



Hemoptysis

CLINID conference
Hunter Ratliff
02/20/2025

*Ages, dates, and other identifying information may have been changed
I have no conflict of interest in relation to this presentation*

Shortcuts



Case: [Start](#) | [Summary slide](#) | [treatment?](#)

Discussion: **Objectives**

- **History:** sanatoriums | pneumothorax | early abx (RIPE was in the [1960s](#)) | modern abx
- **Treatment** (2019): DS | INH resistant | MDR | pill burden (around 500 pills)
- **2025 guidelines:** drug suspect (2HPZM / 2HPM) | MRD (6BPaLM)
- **Surgical procedures:** partial lung resection for MDR | Endobronchial valves

Takeaway slide

Case #1

Case 1: HPI



A **74 y/o M** with PMH including DM, heavy smoking p/w

Case 1: HPI

A **74 y/o M** with PMH including DM, heavy smoking p/w

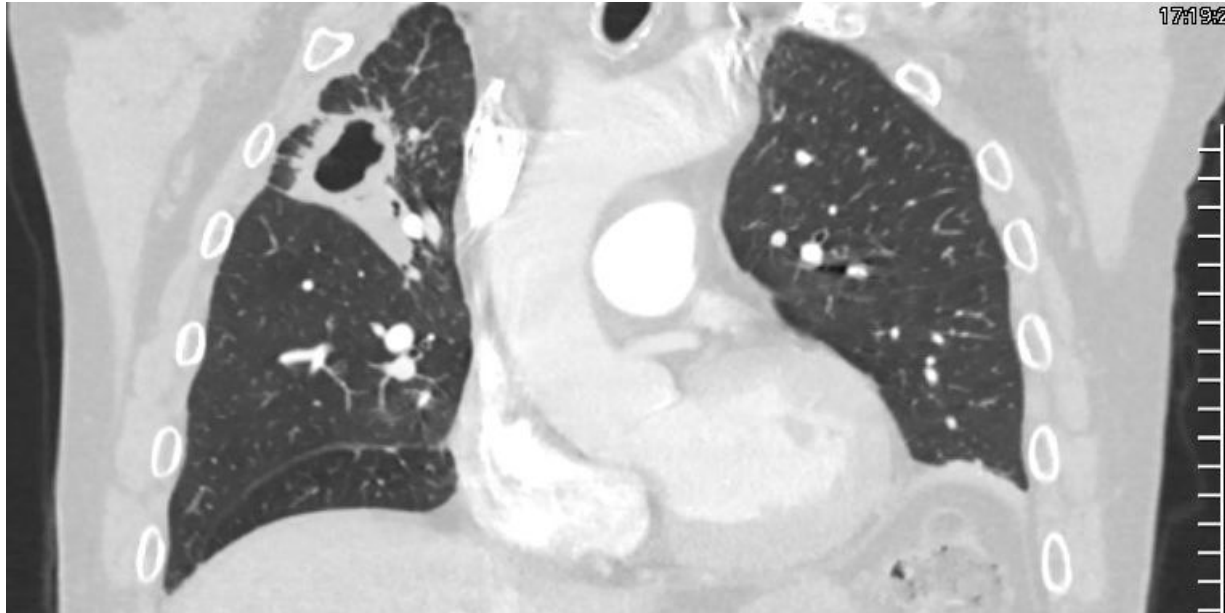

Case 1: HPI

A **74 y/o M** with PMH including DM, heavy smoking

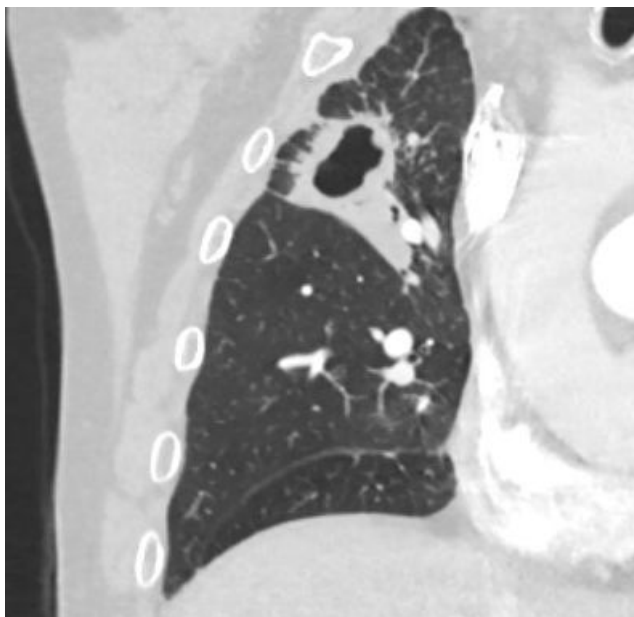

Case 1: HPI

A **74 y/o M** with PMH including DM, **heavy smoking history**

- Usual state of health until 2 months ago, when was admitted for **femur fracture**
- One month ago, **worsening of his chronic cough**
- Had **no dyspnea, faint hemoptysis**
- Cough got bad enough that finally sought medical care



Case 1: Social & Exposure History

Geographic & Travel	<ul style="list-style-type: none">• The patient lives in Ohio with his daughter on many acres of land• He denies recent foreign or domestic travel• Has never traveled to an endemic area for TB
Occupational	<ul style="list-style-type: none">• They are retired, but previously worked as a carpenter (including woodworking)
Substance & needles	<ul style="list-style-type: none">• They are a former heavy drinker (6 pack a day)• Former 2 ppd smoker since age 12 (quit recently due to cough)• No drugs• No unprofessional piercings or tattoos
Animals	<ul style="list-style-type: none">• No farm animal exposures, bird/reptile exposures, or other animal exposure (aside from their pet dogs)
Exposures	<ul style="list-style-type: none">• <u>Never been in or worked in:</u> correctional facilities, homeless shelters, healthcare, group settings. No known contacts with TB• Does work outside (before he got sick), unclear if any soil exposures

Case 1: HPI

A **74 y/o M** with PMH including DM, heavy smoking

- Usual state of health until 2 months ago, when was admitted for **femur fracture**
- One month ago, **worsening of his chronic cough**
- **No dyspnea, faint hemoptysis**
- Cough got bad enough that finally sought medical care

Social / exposures

- Rural Ohio
- Former carpenter, including w/ wood
- Former heavy EtOH & smoke
- Only animal is dogs
- No TB exposures
- Hobbies: outdoors stuff

DDx?

Case 1: Early thoughts?

A **74 y/o M** with PMH including DM, heavy smoking

- Usual state of health until 2 months ago, when **femur fracture**
- One month ago, **worsening of his chronic cough**
- **No dyspnea, faint hemoptysis**
- Cough progressed

DDx?

Social / exposures

- Rural Ohio
- Former carpenter, including w/ wood
- Former heavy EtOH & smoke
- Only animal is dogs
- No TB exposures
- Hobbies: outdoors stuff

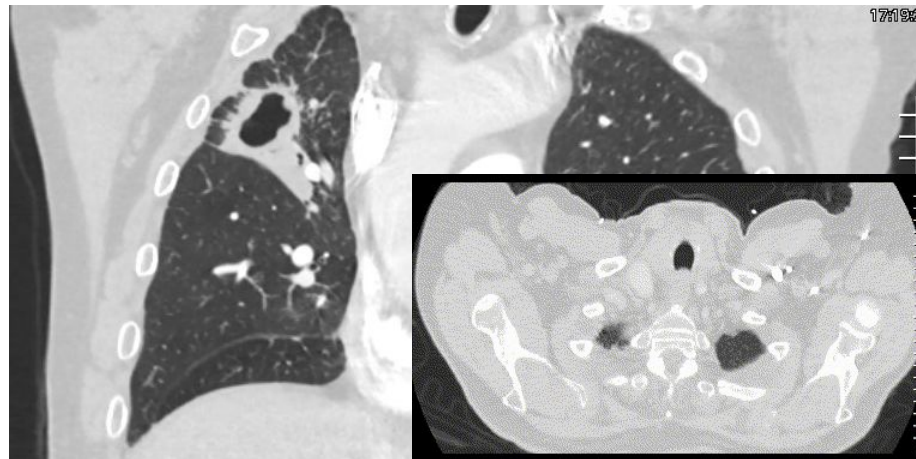

Case 1: From the chart

A **74 y/o M** with PMH including DM, heavy smoking

- One month of cough, hemoptysis

Chart review

April 2021

- RUL cavitary TB
- s/p 30 weeks of RIPE

January 2024

- Seen in our ED with faint hemoptysis
- Discharged from ED

Case 1: From the patient

A **74 y/o M** with PMH including DM, heavy smoking

- One month of cough, hemoptysis
- He states **he was treated for TB**, which was after he says he was first diagnosed a few years ago
- He states he completed this initial course of treatment and **was told that he was "cleared" from TB** by his lung doctor

Chart review

April 2021

- RUL cavitary TB
- s/p 30 weeks of RIPE

January 2024

- Seen in our ED with faint hemoptysis
- Discharged from ED

Case 1: From the patient

A **74 y/o M** with PMH including DM, heavy smoking

- One month of cough, hemoptysis
- Treated for TB once (2021)
- Told by “lung doctor” he was "cleared" from TB

- Report some **weight loss**
 - Attributes to lifestyle changes after hip Fx
- Past week:
 - Subjective **fevers**
 - Occasional **night sweats**
- The day before admission:
 - Frank, **large volume hemoptysis**

Chart review

April 2021

- RUL cavitary TB
- s/p 30 weeks of RIPE

January 2024

- Seen in our ED with faint hemoptysis
- Discharged from ED

Next step?



The health department!

Case 1: From the health dept (late on a Friday)

- Kinda a late consult, but still called the health department before they closed
- The health department immediately knew who the patient was
 - Even without providing any identifiers

Clinical pearl

After you say "*I'm calling from Ruby*", if the health department's TB director knows who your patient is without saying their name, this is **pathognomonic** for **not leaving at 5pm**

Case 1: From the health dept

Collateral from the health department: Further discussion with [REDACTED] at the [REDACTED] health department [REDACTED] provides a more complete story. She states that Mr [REDACTED] is well known to their department, as they have struggled with treatment adherence & directly observed therapy (DOT) across his multiple treatments for tuberculosis. She began working at the department in July of 2024, so she is a little less familiar with the intricacies his prior treatment courses, but she states that Mr [REDACTED] has had 3 rounds of TB treatment with them. The first treatment was in 2021 (following the first positive AFB that we had in our system); off the top of her head she does not know the exact dates or treatment course, but she does know that he had another second treatment course that ended on 9/1/2023 (unclear details on this second course as well).

Case 1: From the health dept

██████████ was notified of the positive AFB on 01 ████████ 24 (that eventually resulted as INH resistant), and he had been on treatment with PZA/RIF/EMB/moxi from February to July of 2024. She states that he had difficulty with DOT (was unable to drive to the Health Department, unreliably participated in video DOT) and did require home visits for DOT. She is planning to fax the official records, but state that his first negative sputum was on 4 ████████ 24 and he had multiple subsequent negative sputums up until the most recent one that they have on 7 ████████ /24 (*which was negative, as would be expected since he was on treatment*); his last positive sputum ██████████ was sent to CDC for resistance testing.

Case 1: From the health dept

Following the negative sputum on [REDACTED] (5 months into treatment) they lost contact with the patient. When they contacted his daughter, she stated he moved to Florida (*this turns out to not be the case*) and the case was brought to the state Health Department. After they failed to reach the patient on multiple attempts, [REDACTED] reports this state closed the case. She has not heard anything from him or about his case until my phone call on [REDACTED]

Case 1: Exam

Vitals: BP 130/66 | Pulse 78 | Temp 36.5 °C | SpO2 **92%** | BMI 28.18 kg/m²

Gen: alert and oriented, NAD, vitals reviewed

Head/Neck: NCAT; trachea appears midline, no gross LAD

ENT: EOMI grossly, anicteric sclerae; MMM

Resp: normal respiratory effort, **frequently coughing with bedside container filled with bright red blood**

CV: RRR; extremities perfused well

GI: non-distended; no TTP

Ext: no clubbing, cyanosis, or edema

Neuro: normal

**At least 150 cc of
bloody sputum in
bedside container**

Case 1: Prior micro

From the ED visit a years ago where he was discharged from the ED

April 2021	MIC	Intrp
Ethambutol, low	5	S
Ethambutol, high	8	S
Isoniazid, low	0.1	S
Isoniazid, high	0.4	S
Pyrazinamide	300	S
Rifampin	1	S

Jan 2024	Intrp
Ethambutol (5.0 mcg/mL)	S
Isoniazid (0.1 mcg/mL)	R
Isoniazid (0.4 mcg/mL)	R
Pyrazinamide	S
Rifampin (5.0 mcg/mL)	S

Case 1: Summary

A 74 y/o M with PMH including DM, HTN, prior RUL cavitary TB (with **multiple treatment courses**), most recently incompletely treated with RIF/PZA/EMB/Moxi (02/2024 - 07/2024) who now presents with hemoptysis

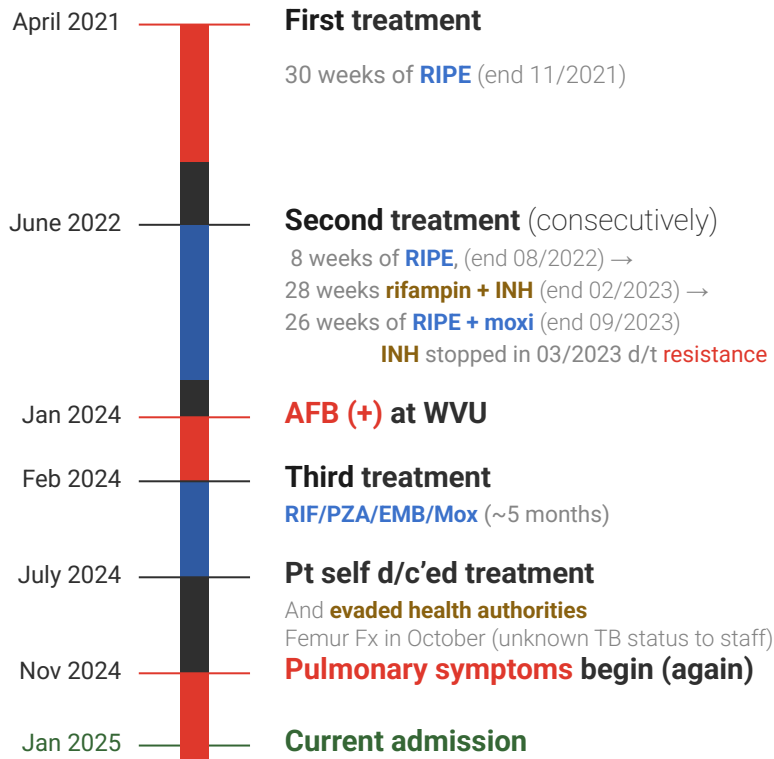

Jan 2024	
Ethambutol	S
Isoniazid	R
Pyrazinamide	S
Rifampin	S

Case 1: Summary

A 74 y/o M with PMH including DM, HTN, prior RUL cavitary TB (with **multiple treatment courses**), most recently incompletely treated with RIF/PZA/EMB/Moxi (02/2024 - 07/2024) who now presents with hemoptysis

❖ **DDx?**
❖ **Workup?**

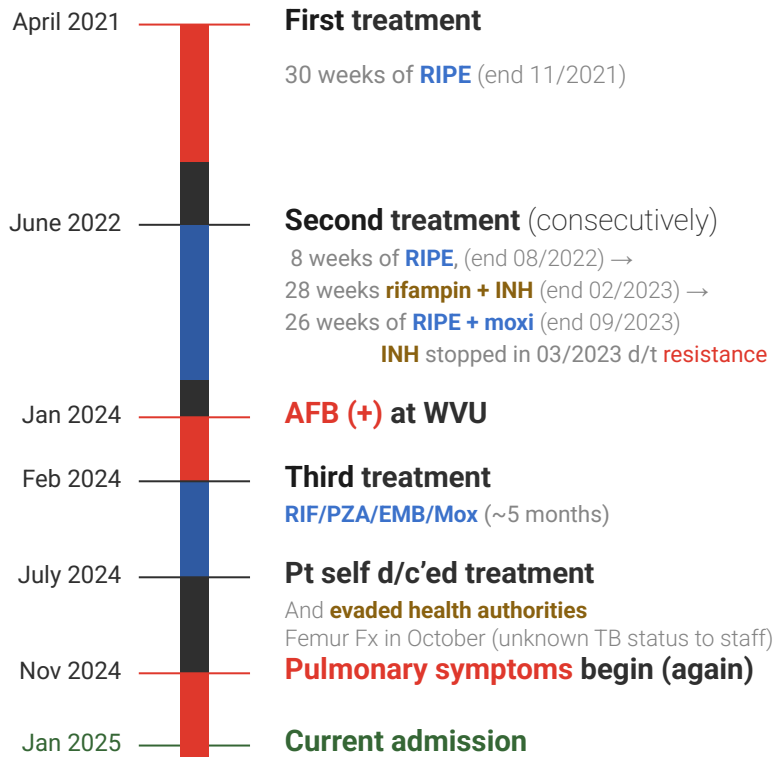

Jan 2024	
Ethambutol	S
Isoniazid	R
Pyrazinamide	S
Rifampin	S

Case 1: Workup

BAL	Result
Routine Cx	
Fungal / AFB	
Asp GM	
MTB PCR	
PJP PCR	

Serum / Urine	Result
Histo Ag	
Blasto Ag	
Crypto Ag	
Fungitell	
Asp GM	

Case 1: Workup

BAL	Result
Routine Cx	
Fungal / AFB	
Asp GM	
MTB PCR	
PJP PCR	

Serum / Urine	Result
Histo Ag	Neg
Blasto Ag	Neg
Crypto Ag	Neg
Fungitell	Neg
Asp GM	Neg

Case 1: Workup

BAL	Result
Routine Cx	Neg
Auramine smear	(+)
Asp GM	Neg
MTB PCR	
PJP PCR	Neg

Serum / Urine	Result
Histo Ag	Neg
Blasto Ag	Neg
Crypto Ag	Neg
Fungitell	Neg
Asp GM	Neg

Case 1: Workup

BAL	Result
Routine Cx	Neg
Fungal / AFB	(+)
Asp GM	Neg
MTB PCR	(+)
PJP PCR	Neg

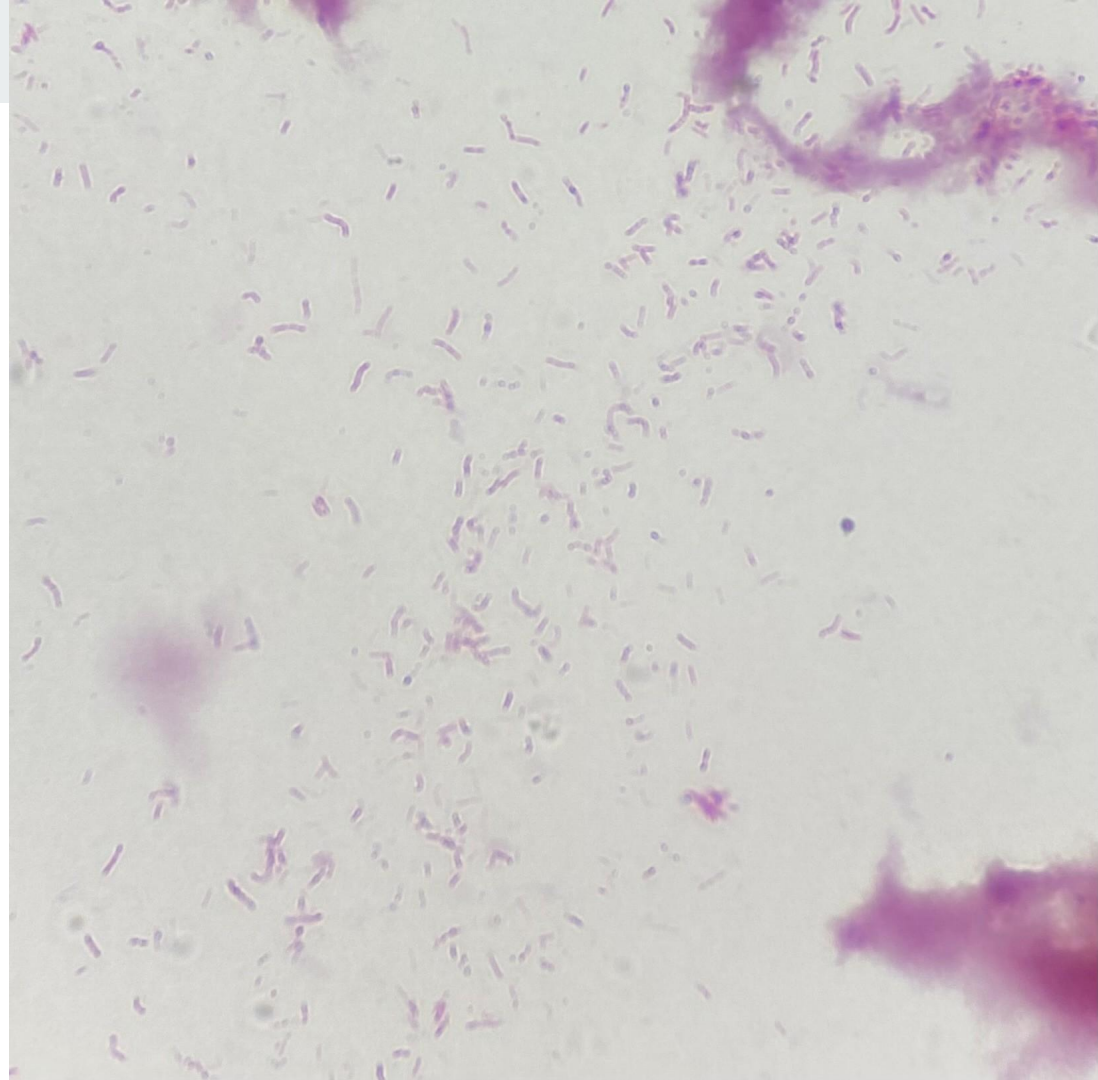

Case 1: Treatment

A 74 y/o M with PMH including DM, HTN, prior RUL cavitary TB (with **multiple treatment courses**), most recently **incompletely treated** with **RIF/PZA/EMB/Moxi** (02/2024 - 07/2024) who now presents with hemoptysis

How do we treat this?

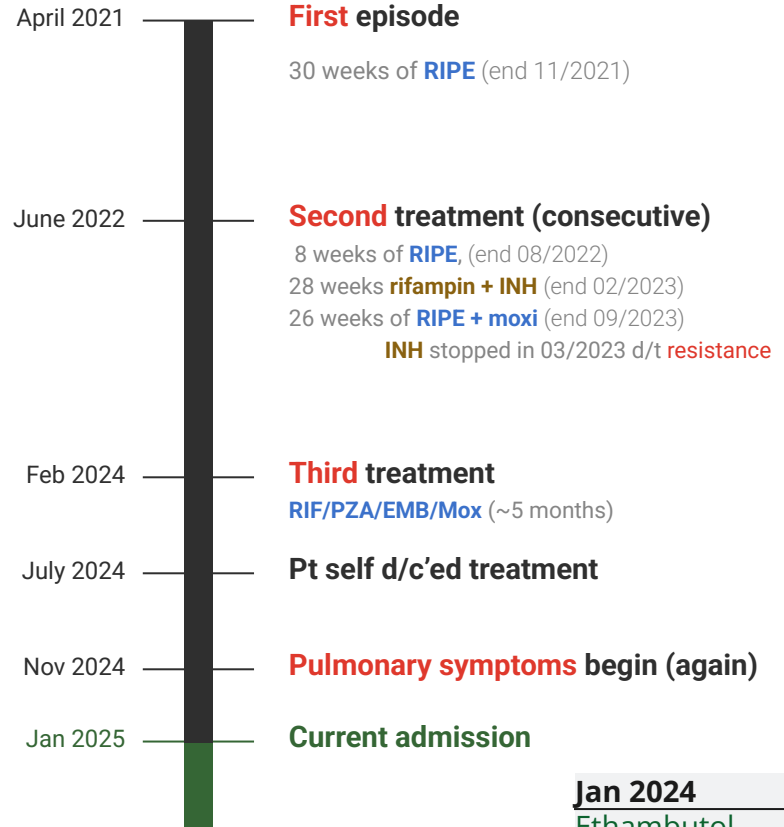

Jan 2024	
Ethambutol	S
Isoniazid	R
Pyrazinamide	S
Rifampin	S

Case 1: Hospital course

- Hosp day 3: **Intubated** for hemoptysis

Day 2: Started on daily

1. Rifampin 600 mg
2. Pyrazinamide 2 g
3. Ethambutol 1600 mg (15 mg/kg)
4. Levofloxacin 750 mg

Case 1: Hospital course

- **Hosp day 3:** Intubated for hemoptysis
- **Day 4:** **Endobronchial blocker** placed
- **Day 5:** Severe bleeding, **IR embolization** of right bronchial artery

Day 2: Started on daily

1. **Rifampin** 600 mg
2. **Pyrazinamide** 2 g
3. **Ethambutol** 1600 mg (15 mg/kg)
4. **Levofloxacin** 750 mg

CT surgery

Deferred lobectomy until more stable

Case 1: Hospital course

- **Hosp day 3:** Intubated for hemoptysis
- **Day 4:** Endobronchial blocker placed
- **Day 5:** Severe bleeding, IR embolization of right bronchial artery
- **Day 6:** Endobronchial block removed, less bleeding
- **Day 7:** Added **INH**, discussed **bronchial valve**

Day 2: Started on daily

1. **Rifampin** 600 mg
2. **Pyrazinamide** 2 g
3. **Ethambutol** 1600 mg (15 mg/kg)
4. **Levofloxacin** 750 mg

Day 7: added **isoniazid** 300

CT surgery

Deferred lobectomy until more stable

Pulmonology

Discussed **bronchial valve**

Case 1: Hospital course

- **Hosp day 3:** Intubated for hemoptysis
- **Day 4:** Endobronchial blocker placed
- **Day 5:** Severe bleeding, IR embolization of right bronchial artery
- **Day 6:** Endobronchial block removed, less bleeding
- **Day 10:** **Bleeding again**, x2 endobronchial blockers
- **Day 13:** **Extubated**
- **Day 18:** **Downgraded from MICU** to floor

Day 2: Started on daily

1. **Rifampin** 600 mg
2. **Pyrazinamide** 2 g
3. **Ethambutol** 1600 mg (15 mg/kg)
4. **Levofloxacin** 750 mg

Day 7: added isoniazid 300

CT surgery

Deferred lobectomy until more stable

Pulmonology

Discussed bronchial valve

Case 1: Hospital course

- **Hosp day 3:** Intubated for hemoptysis
- **Day 4:** Endobronchial blocker placed
- **Day 5:** Severe bleeding, IR embolization of right bronchial artery
- **Day 6:** Endobronchial block removed, less bleeding
- **Day 10:** Bleeding again, x2 endobronchial blockers
- **Day 13:** Extubated
- **Day 18:** Downgraded from MICU to floor
- **Day 21:** **Hypoxia**, intubated and sent to MICU
- **Day 22:** **Severe shock**, had **GOC** → **CMO**
- **Day 23:** Expired

Day 2: Started on daily

1. **Rifampin** 600 mg
2. **Pyrazinamide** 2 g
3. **Ethambutol** 1600 mg (15 mg/kg)
4. **Levofloxacin** 750 mg

Day 7: added isoniazid 300

CT surgery

Deferred lobectomy until more stable

Pulmonology

Discussed bronchial valve

Nat Jewish Results

MDR TB line probe

Interpretation

rpoB

katG

inhA

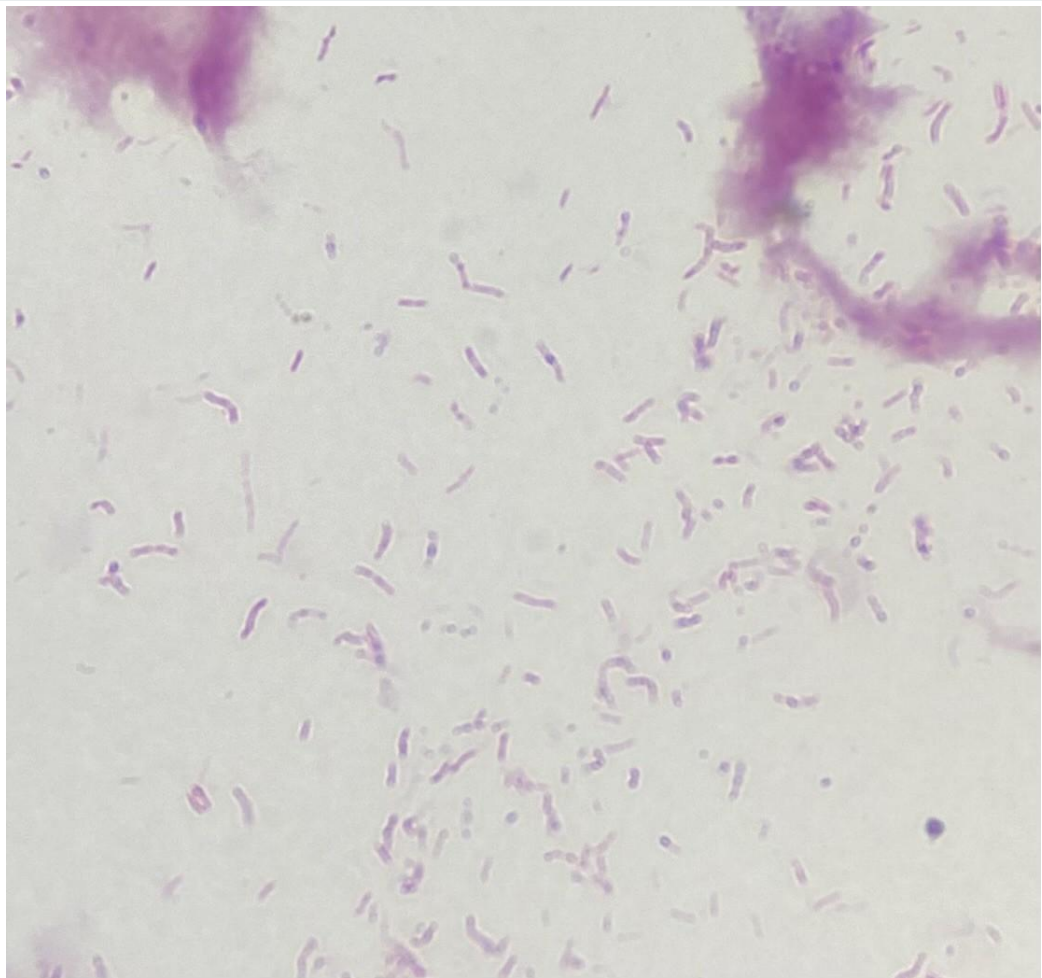

Nat Jewish Results

MDR TB line probe	Interpretation	
rpoB	No mutations present	Suggests rifampin susceptibility
katG	No mutations present	Suggests susceptibility to
inhA	No mutations present	isoniazid

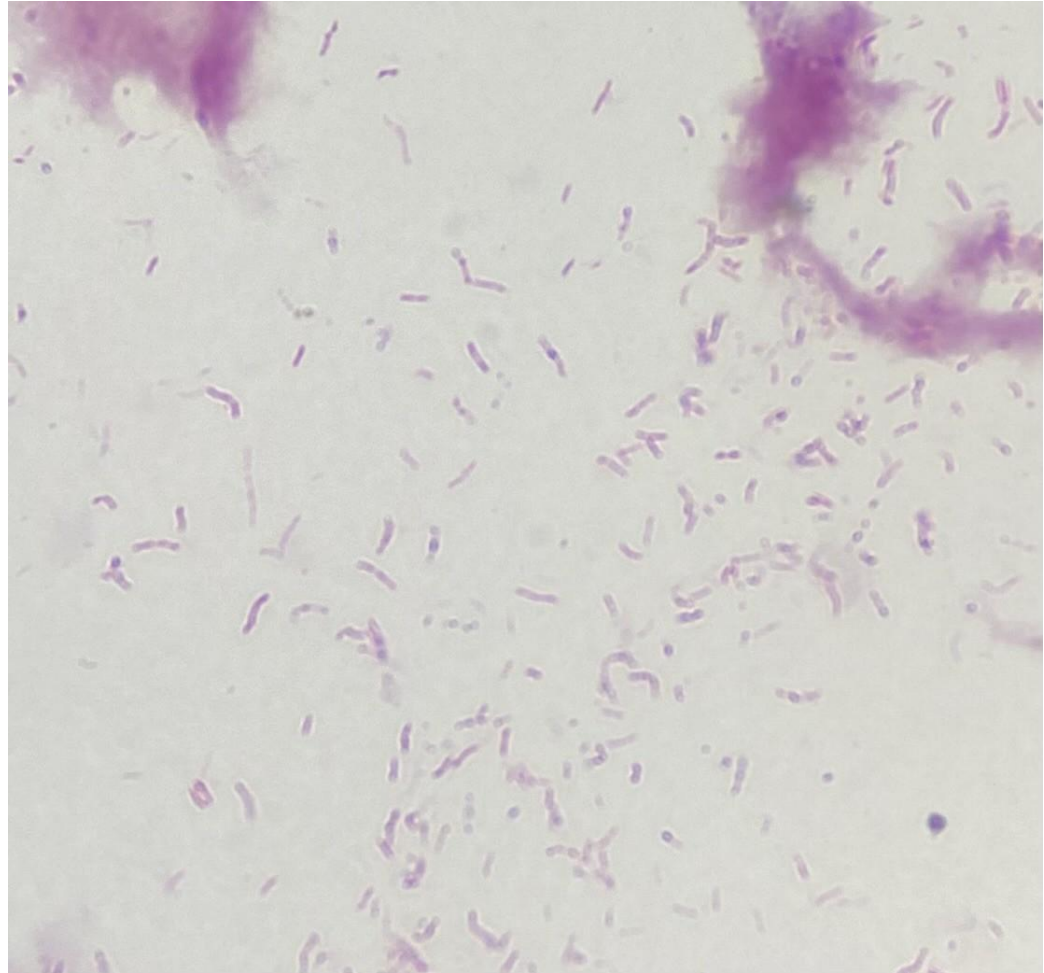

Nat Jewish Results

MDR TB line probe	Interpretation	
rpoB	No mutations present	Suggests rifampin susceptibility
katG	No mutations present	Suggests susceptibility to
inhA	No mutations present	isoniazid

This admission	Intrp
Ethambutol (5.0 mcg/mL)	S
Isoniazid (0.1 mcg/mL)	R
Isoniazid (0.4 mcg/mL)	R
Pyrazinamide	S
Rifampin (5.0 mcg/mL)	S

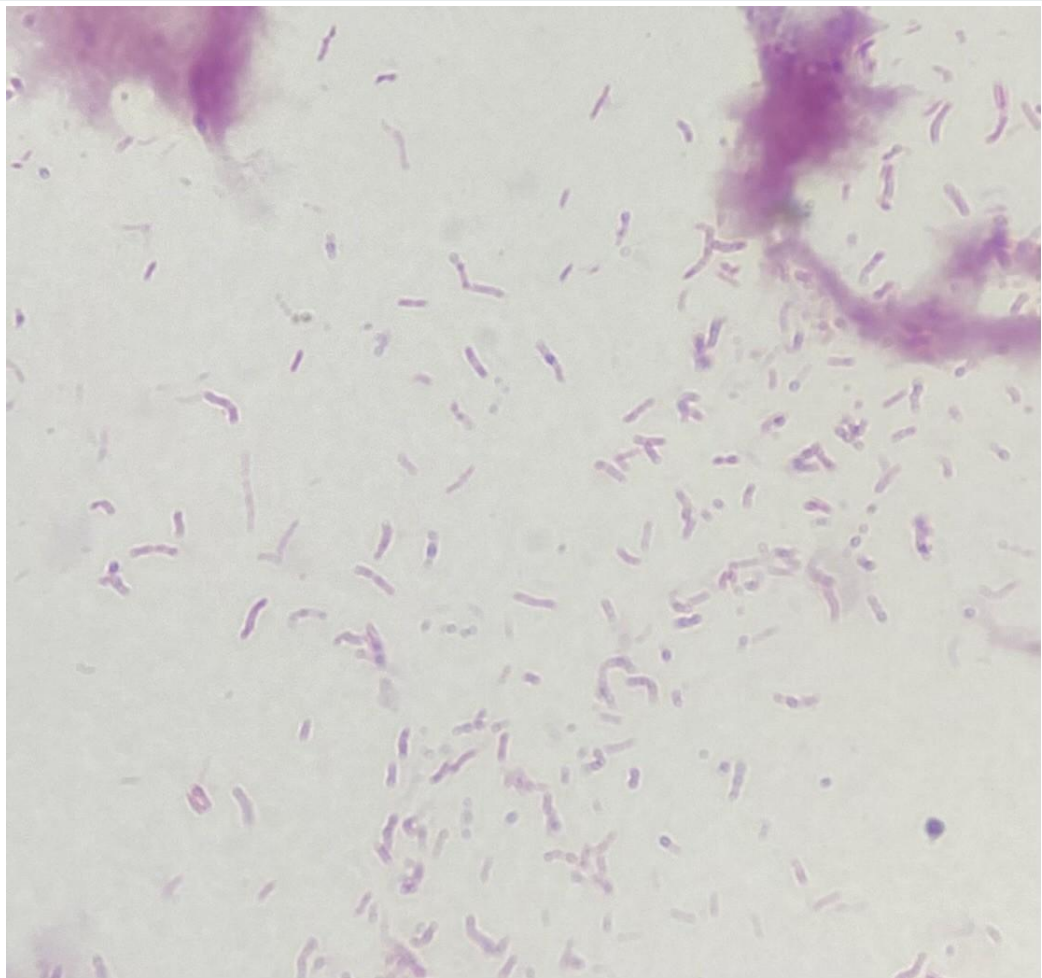

Discussion



Links to articles discussed
here



Pulmonary tuberculosis



- Review the **history of *M tuberculosis* treatment**
- Describe the **treatment for** drug susceptible, INH resistant, & MRD TB
- Compare the **prior guidelines** (2019) with the new **2025 ATS/CDC/ERS/IDSA guidelines**
- Discuss the **role for surgical procedures** in the treatment of MTB
- Appraise the **evidence for endobronchial valves**

**Review the history
of tuberculosis & its
treatment**



From the history books

- TB has been around a *long* time
 - Archeologists have found Egyptian mummies (2400 BC) with skeletal Pott's lesions
- In the **Middle Ages**, it was believed people could be cured from TB after a **royal touch** from a king or queen
 - During that time TB killed ~ 1 in 4 in Europe
- **1720**: English physician **Benjamin Marten** proposed that TB was **infectious in origin**
- **1882**: Dr. **Robert Koch** announced the discovery of *Mycobacterium tuberculosis*
- **Sanatorium Movement**: Patients were treated with "**rest cure**" with fresh air & nutrition

APRIL 8, 1899.]

THE OPEN-AIR TREATMENT

REMARKS

ON THE

OPEN-AIR CURE OR HYGIENIC TREATMENT OF CONSUMPTION.

By C. THEODORE WILLIAMS, M.D., F.R.C.P.,

Consulting-Physician to the Hospital for Consumption and Diseases of
the Chest, Brompton.

THERE is no doubt that the introduction of the so called "open-air" treatment of consumption into English practice has conferred, and probably will confer, great benefits on phthisical patients, and it is not improbable that, in spite of our changeable climate, it will be given a fair trial, especially as English people as a rule have no insuperable objection to fresh air.

Hx of TB treatment: Surgicillin

- **Most of human history:** Nothing, you died
- **Around 1900:** First treatment for TB discovered and it was... **surgery**, not medicine
- Specifically, inducing a **pneumothorax**

Hx of TB treatment: Surgicillin

- **Most of human history:** Nothing, you died
- **Around 1900:** Artificial **pneumothorax**
 - French physicians noted patients with *spontaneous pneumothoraces* improved
 - Recall that TB is an **obligate aerobe**, so it will die without oxygen
- Of course, the procedure itself was quite risky

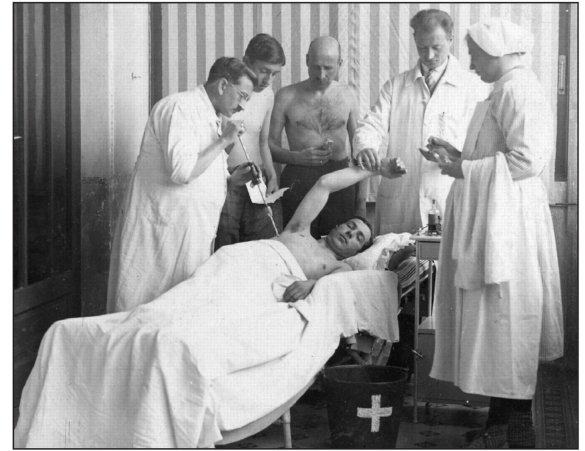

Pleurocentesis is performed while the patient is being monitored (circa 1930). [Rakovich 2010](#) [1.1]

Hx of TB treatment: First antimycobacterials

- **Most of human history:** Nothing, you died
- **Around 1900:** Artificial **pneumothorax** (works because obligate aerobe)
- **1940s:** First antimycobacterials discovered
- **Streptomycin (1943):** did a good job, but rapid development of resistance developed
 - Was slowed when **para-aminosalicylic acid (1946)** was added

Hx of TB treatment: First antimycobacterials

- **Most of human history:** Nothing, you died
- **Around 1900:** Artificial **pneumothorax** (works because obligate aerobe)
- **1940s:** First antimycobacterials discovered
- **Streptomycin (1943):** did a good job, but rapid development of resistance developed
 - Slowed with **para-aminosalicylic acid (1946)**
- **Isoniazid (1952):** Major breakthrough
 - Combination therapy with **streptomycin + PAS + INH** allowed for cures (but still high failure rates)

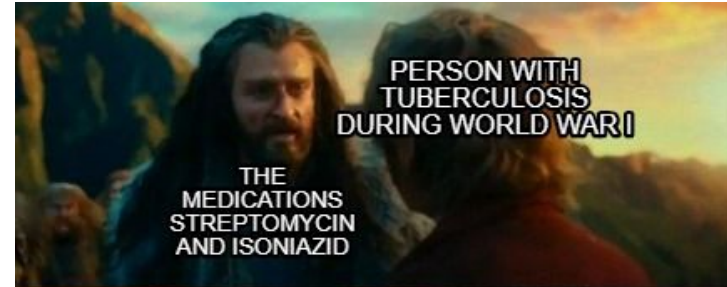

Hx of TB treatment: First antimycobacterials

- **Most of human history:** Nothing, you died
- **Around 1900:** Artificial **pneumothorax** (works because obligate aerobe)
- **1940s:** First antimycobacterials discovered
- **Streptomycin (1943):** did a good job, resistance developed
 - Slowed with **para-aminosalicylic acid (1946)**
- **Isoniazid (1952):** Major breakthrough
 - Combination therapy with **streptomycin + PAS + INH** allowed for cures (but still high failure rates)
- **Rifampin (1965):** When used in combination therapy, allowed for **shorter duration**
 - Decreased from 18 to 24 months → **6 - 9 months**



Hx of TB treatment: First antimycobacterials

- **Most of human history:** Nothing, you died
- **Around 1900:** Artificial **pneumothorax** (works because obligate aerobe)
- **1940s:** First antimycobacterials discovered
- **Streptomycin (1943):** did a good job, resistance developed
 - Slowed with **para-aminosalicylic acid (1946)**
- **Isoniazid (1952):** Major breakthrough
 - Combination therapy with **streptomycin + PAS + INH** allowed for cures (but still high failure rates)
- **Rifampin (1965):** When used in combination therapy, allowed for **shorter duration**
 - Decreased from 18 to 24 months → **6 - 9 months**
- **RIPE** (AKA RIF/INH/PZA/EMB) has been standard of care (for drug susceptible TB) **since 1960s** ^[1.2]



Hx of TB treatment: Modern era

- **Most of human history:** Nothing, you died
- **Around 1900:** Artificial **pneumothorax** (works because obligate aerobe)
- **1940 - 1960s:** first antimycobacterials discovered, including **streptomycin** (1943), **INH** (1952), **PZA** (1954), **EMB** (1961), **RIF** (1965)
 - **Since 1960s:** **RIPE** has been standard of care (for drug susceptible TB)
- **1980s:** Emergence of **MRD-TB** (resistant to RIF & INH) and later **XDR-TB**
 - Had to start using second line drugs (fluoroquinolones, aminoglycosides)
- **2010s:** Novel TB drugs discovered
 - **Bedaquiline** (2012)
 - **Delamanid** (2014)
 - **Pretomanid** (2019)
- Used in treatment for MDR-TB (**BPaLM**)

Abbreviations

RIF	Rifampin
INH	Isoniazid
PZA	Pyrazinamide
EMB	Ethambutol
RPT	Rifapentine
BDQ	Bedaquiline
Pa	Pretomanid
LZD	Linezolid
MOX	Moxifloxacin
LFX	Levofloxacin



Treatment of pulmonary tuberculosis

We'll save XDR-TB for another day



- Review the **history of *M tuberculosis* treatment**
- Describe the **treatment for**
 - **Drug susceptible** TB
 - **INH resistant** TB
 - **MRD** TB
- Compare the **prior (2019) guidelines** with the new **2025 ATS/CDC/ERS/IDSA guidelines**
- Discuss the **role for surgical procedures** in the treatment of MTB
- Appraise the **evidence for endobronchial valves**

Current* treatment for DS pulmonary TB [3.1 - [CDC](#)]

- **Cavitary lesion -and- positive culture at 2 months**
 - 2HRZE followed by 7HR

	1	2	3	4	5	6	7	8	9
Drug susceptible cavitary & Cx+	INH RIF PZA EMB		INH RIF						

Abbreviations

RIF	Rifampin
INH	Isoniazid
PZA	Pyrazinamide
EMB	Ethambutol

Current* treatment for DS pulmonary TB [3.1 - [CDC](#)]

- **Cavitary lesion -and- positive culture at 2 months**
 - 2HRZE followed by 7HR
- None of **Box 1**
 - 2HRZE followed by 4HR

Consider extension (**Box 1**)

- Cavitary lesion
- Positive Cx @ 2 mo
- Smoker
- Underweight
- Diabetes
- HIV / immunosuppression
- Extensive disease

	1	2	3	4	5	6	7	8	9
Drug susceptible non-cavitary	INH RIF		INH RIF						
Drug susceptible cavitary & Cx+	PZA EMB		INH RIF						

Abbreviations

RIF	Rifampin
INH	Isoniazid
PZA	Pyrazinamide
EMB	Ethambutol

Current* treatment for DS pulmonary TB [3.1 - [CDC](#)]

- **Cavitary lesion -and- positive culture at 2 months**
 - 2HRZE followed by 7HR
- None of **Box 1**
 - 2HRZE followed by 4HR
- At least 1 of **Box 1**
 - 2HRZE followed by 4HR
 - Consider extension of 4HR to 7HR

Consider extension (**Box 1**)

- Cavitary lesion
- Positive Cx @ 2 mo
- Smoker
- Underweight
- Diabetes
- HIV / immunosuppression
- Extensive disease

	1	2	3	4	5	6	7	8	9	
Drug susceptible non-cavitary	INH RIF		INH RIF				+/- INH & RIF			
Drug susceptible cavitary & Cx+	PZA EMB		INH RIF							

Abbreviations

- RIF** Rifampin
- INH** Isoniazid
- PZA** Pyrazinamide
- EMB** Ethambutol

INH-Resistant pulmonary TB ^[1.5] 2019 guidelines

- Monoresistance to INH is frequent (8% worldwide)
- 6 months of **RIF** / **PZA** / **EMB** ~~-plus-~~ fluoroquinolone (**MOX**, **LFX**)
- In select cases, can drop **PZA** after 2 months
 - Noncavitary + low burden of disease or PZA toxicity

Abbreviations

RIF	Rifampin
INH	Isoniazid
PZA	Pyrazinamide
EMB	Ethambutol
MOX	Moxifloxacin
LFX	Levofloxacin

INH-Resistant pulmonary TB ^[1.5] 2019 guidelines

- Monoresistance to INH is frequent (8% worldwide)
- 6 months of **RIF** / **PZA** / **EMB** ~~-plus-~~ fluoroquinolone (**MOX**, **LFX**)
- In select cases, can drop **PZA** after 2 months
 - Noncavitary + low burden of disease or PZA toxicity

	1	2	3	4	5	6	7	8	9	
Drug susceptible non-cavitary	INH RIF PZA EMB		INH RIF			INH RIF		+/- INH & RIF		
Drug susceptible cavitary & Cx+										
INH-R pulm TB	RIF MOX/LFX EMB					Consider extension if cavitary or Cx+ at 2 months				
										PZA

Abbreviations	
RIF	Rifampin
INH	Isoniazid
PZA	Pyrazinamide
EMB	Ethambutol
MOX	Moxifloxacin
LFX	Levofloxacin

MDR pulmonary TB [1.5] 2019 guidelines

MDR-TB: Resistance to rifampin +/- resistance to INH

Prior guidelines suggested:

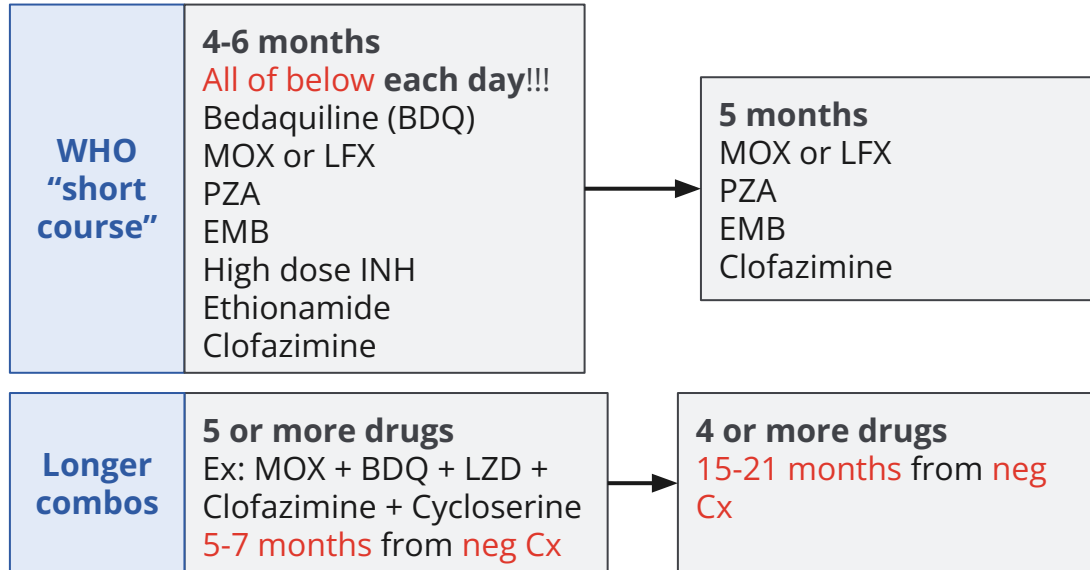

Abbreviations

RIF	Rifampin
INH	Isoniazid
PZA	Pyrazinamide
EMB	Ethambutol
RPT	Rifapentine
BDQ	Bedaquiline
Pa	Pretomanid
LZD	Linezolid
MOX	Moxifloxacin
LFX	Levofloxacin

Treatment for TB: Pill burden

- Standard treatment for *drug susceptible* TB is **466** (6 mo) to **650** (9 mo) doses*
- Our patient had approximately **8300 doses*** over **113 weeks**

	1	2	3	4	5	6	7	8	9
Drug susceptible non-cavitary	INH RIF		INH RIF				+/- INH & RIF		
Drug susceptible cavitary & Cx+	PZA EMB					INH RIF			

*Note

This is just a ballpark estimate, since one dose may actually be more pills (e.g. one dose of PZA for him is multiple pills)

He also didn't take all of his pills, but regardless, this is a lot of meds

Treatment for TB: Pill burden

Additional from the patient: When I informed the patient that I had spoken with the health department, he stated that he stopped taking the pills in July because it was too many pills (he denied experiencing any specific side effects) and because he thought that he had already

Patient Perspective ^[1.3]

“For individuals living with tuberculosis, the path from diagnosis to recovery is full of many challenges... The **difficulty of high pill burden**, medication side effects and **long treatment regimens** is frequently discussed by TB survivors in *We Are TB* support meetings. During my own treatment **I felt the weight of 16 pills in my hand every morning**, and of stigma, financial cost and isolation... Progress to shorten this journey and to ease these burdens is valued by patients.”

Kelly Holland, *We Are TB* patient advocate



Updates on the Treatment of Drug-Susceptible and Drug-Resistant Tuberculosis ^[1.3]

An Official ATS/CDC/ERS/IDSA Clinical Practice Guideline (Jan 2025)



2025 guidelines^[1.3]: Shorter course of treatment?

Patients: In adults/adolescents with drug-susceptible pulmonary TB

Intervention: 4-month regimen (2HPZM / 2HPM)

- 2 months: INH, rifaPentine, PZA, Moxifloxacin –followed by–
- 2 months: INH, rifaPentine, Moxifloxacin

Comparison: 6 month regimen (2HRZE / 4HR), standard of care

- 2 months: INH / RIF / PZA / EMB –followed by–
- 4 months: INH / RIF

Outcome: Safety and efficacious

Abbreviations

RIF	Rifampin
INH	Isoniazid
PZA	Pyrazinamide
EMB	Ethambutol
RPT	Rifapentine
MOX	Moxifloxacin

	1	2	3	4	5	6
INH			INH			INH
RIF			RIF			RIF
PZA		PZA				
EMB		EMB				
INH			INH			
RPT			RPT			
PZA		PZA				
MOX			MOX			

2025 guidelines^[1.3]: Shorter course of treatment?

Patients: In adults/adolescents with drug-susceptible pulmonary TB

Intervention: 4-month regimen (2HPZM / 2HPM)

- 2 months: INH, rifaPentine, PZA, Moxifloxacin –followed by–
- 2 months: INH, rifaPentine, Moxifloxacin

Comparison: 6 month regimen (2HRZE / 4HR), standard of care

- 2 months: INH / RIF / PZA / EMB –followed by–
- 4 months: INH / RIF

Outcome: Safety and efficacious

Abbreviations	
RIF	Rifampin
INH	Isoniazid
PZA	Pyrazinamide
EMB	Ethambutol
RPT	Rifapentine
MOX	Moxifloxacin

Recommendation: 2HPZM / 2HPM

Conditional recommendation, moderate certainty of evidence

Dorman et al (2021) [1.4]

Based largely off of large RTC (13 countries, 34 sites) published in NEJM (2021)

- All had culture confirmed susceptibility to INH, rifampin, & fluoroquinolones
- **Non-inferiority study:** 84.6% were cured (vs. 85.4% in control)

Abbreviations

RIF	Rifampin
INH	Isoniazid
PZA	Pyrazinamide
EMB	Ethambutol
RPT	Rifapentine
MOX	Moxifloxacin

P: Adults with susceptible pulm TB
I: 2HPZM / 2HPM
C: 2HRZE / 4HR
O: Safety & efficacious

Dorman et al (2021) [1.4]

P: Adults with susceptible pulm TB
I: 2HPZ**M** / 2H**PM**
C: 2HR**ZE** / 4H**R**
O: Safety & efficacious

Abbreviations	
RIF	Rifampin
INH	Isoniazid
PZA	Pyrazinamide
EMB	Ethambutol
RPT	Rifapentine
MOX	Moxifloxacin

Found **no significant differences** in outcomes were identified for 4 mo RPT-MOX and 6 mo SoC on the basis of:

- **Smear grade**
- **Cavitation**
- **Radiologic extent**

Dorman et al (2021) ^[1.4]

P: Adults with susceptible pulm TB
I: 2HPZ**M** / 2H**PM**
C: 2HR**ZE** / 4**HR**
O: Safety & efficacious

Abbreviations

RIF Rifampin
INH Isoniazid
PZA Pyrazinamide
EMB Ethambutol
RPT Rifapentine
MOX Moxifloxacin

Found **no significant differences** in outcomes were identified for 4 mo RPT-MOX and 6 mo SoC on the basis of:

- Smear grade
- Cavitation
- Radiologic extent

		1	2	3	4	5	6	7	8	9
Standard of care	INH	INH				INH		+/- INH		
	RIF	RIF				RIF		+/- RIF		
	PZA	PZA								
	EMB	EMB								
New way?	INH	INH								
	RPT	RPT								
	PZA	PZA								
	MOX	MOX								

Dorman et al (2021) [1.4]

P: Adults with susceptible pulm TB
I: 2HPZM / 2HPM
C: 2HRZE / 4HR
O: Safety & efficacious

Abbreviations

RIF	Rifampin
INH	Isoniazid
PZA	Pyrazinamide
EMB	Ethambutol
RPT	Rifapentine
MOX	Moxifloxacin

Found **no significant differences** in outcomes were identified for 4 mo RPT-MOX and 6 mo SoC on the basis of:

- **Smear grade**
- **Cavitation**
- **Radiologic extent**
- **Age** - Most were <35 yo
- **Diabetes** - Not well represented
- **Body weight** - Not well represented
- **HIV status** (8% were people living with HIV)

Dorman et al (2021) [1.4]

Abbreviations	
RIF	Rifampin
INH	Isoniazid
PZA	Pyrazinamide
EMB	Ethambutol
RPT	Rifapentine
MOX	Moxifloxacin

Consideration of FQ toxicity: In the US, our folks with TB are older (compared to the trial) and have more comorbidities, QT prolonging meds, and risk of FQ toxicity

Reduced ocular complications: Because RPT-MOX avoids the potential ocular toxicity of EMB

- Also clears **sputum Cx faster**

Higher pill burden: RPT-MOX regimen increases daily pill burden, especially compared with fixed-dose combinations

- But **shorter duration:** 4 months (vs 9 mo) for cavitary TB

Used DOT: As it the case for many trials

INH-mono-resistance: Doesn't apply, excluded from the study

P: Adults with susceptible pulm TB
I: 2HPZM / 2HPM
C: 2HRZE / 4HR
O: Safety & efficacious

2025 guidelines^[1.3]: Shorter courses for MDR

Patients: In adults/adolescents with rifampin-resistant pulmonary TB

- Also includes those intolerant of rifampin

Intervention: 6-month regimen BPaL(M)

- Bedaquiline 400 daily x 2 wk, then 200 x3/week
- Pretomanid 200 daily
- Linezolid 600 daily
- Moxifloxacin 400 daily (if susceptible)

Comparison: 15+ month regimen (2019 guidelines), standard of care

Outcome: Safety and efficacious

Abbreviations

RIF	Rifampin
INH	Isoniazid
PZA	Pyrazinamide
EMB	Ethambutol
RPT	Rifapentine
BDQ	Bedaquiline
Pa	Pretomanid
LZD	Linezolid
MOX	Moxifloxacin
LFX	Levofloxacin

2025 guidelines^[1.3]: Shorter courses for MDR

Patients: In adults/adolescents with rifampin-resistant pulmonary TB

- Also includes those intolerant of rifampin

Intervention: 6-month regimen BPaL(M)

- Bedaquiline 400 daily x 2 wk, then 200 x3/week
- Pretomanid 200 daily
- Linezolid 600 daily
- Moxifloxacin 400 daily (if susceptible)

Comparison: 15+ month regimen (2019 guidelines), standard of care

Outcome: Safety and efficacious

Abbreviations

RIF	Rifampin
INH	Isoniazid
PZA	Pyrazinamide
EMB	Ethambutol
RPT	Rifapentine
BDQ	Bedaquiline
Pa	Pretomanid
LZD	Linezolid
MOX	Moxifloxacin
LFX	Levofloxacin

Recommendation: BPaL(M)

Strong recommendation, very low certainty of evidence

2025 guidelines^[1.3]: Shorter courses for MDR

Based off of TB-PRACTECAL trial (2022) & ZeNix (2022) vs observational data

ZeNix trial: Compared to WHO data (SoC), BPaL had

- Higher **treatment success** (100% vs. 74%)
- Lower **mortality** (0% vs. 11%)
- Higher **grade 3+ adverse events** (14% vs 5%) **?reporting bias**

TB-PRACTECAL: Compared to SoC, BPaL had

- Higher **treatment success** (77% vs. 52%)
- Lower **grade 3+ adverse events** (20% vs 51%)

Abbreviations

RIF	Rifampin
INH	Isoniazid
PZA	Pyrazinamide
EMB	Ethambutol
RPT	Rifapentine
BDQ	Bedaquiline
Pa	Pretomanid
LZD	Linezolid
MOX	Moxifloxacin
LFX	Levofloxacin

P: Adults with INH-R TB
I: 6BPaL(M)
C: 15+ months SoC
O: Safety & efficacious



Surgical treatment for pulmonary tuberculosis



- Review the **history of *M tuberculosis* treatment**
- Describe the **treatment for** drug susceptible, INH resistant, & MRD TB
- Compare the **prior (2019) guidelines** with the new **2025 ATS/CDC/ERS/IDSA guidelines**
- Discuss the **role for surgical procedures** in the treatment of MTB
- Appraise the **evidence for endobronchial valves**

Surgi-cillin for TB: 2019 ATS/CDC/ERS/IDSA [1.5]

- For adults with **MDR-TB** receiving antimicrobial therapy, they **suggest** *elective* **partial lung resection (lobectomy or wedge resection)** vs medical therapy alone
 - Conditional recommendation, very low certainty in the evidence

Surgi-cillin for TB: 2019 ATS/CDC/ERS/IDSA ^[1.5]

- For adults with **MDR-TB** receiving antimicrobial therapy, they **suggest** *elective* **partial lung resection (lobectomy or wedge resection)** vs medical therapy alone
 - Conditional recommendation, very low certainty in the evidence
- Difficult topic to do meta-analysis on
 - Partial lung resection had a **higher probability of treatment success** (aOR: 3.0; 95% CI, 1.5–5.9), as opposed to treatment failure, relapse, or death
 - **Treatment success** in XDR-TB was **lower in patients who had surgery** (aOR: 0.4; 95% CI, 0.2–0.9)
- Committee believed partial lung resection would be of net benefit for patients with **strong risk of relapse**
 - Similar to 2016 WHO guidelines

Endobronchial valves



- Much like pneumothoraces, **surgical resection** has high rates of complications
 - There might be **another answer**

Endobronchial valves

- Much like pneumothoraces, **surgical resection** has high rates of complications
 - There might be another answer
- Enter: **Endobronchial valves!**

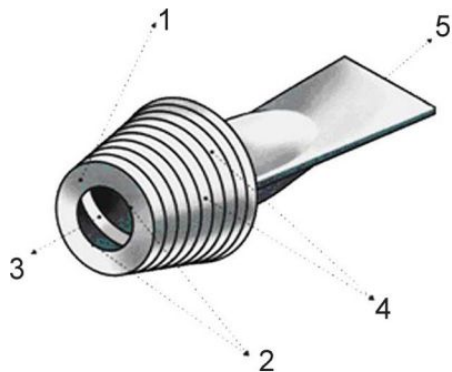
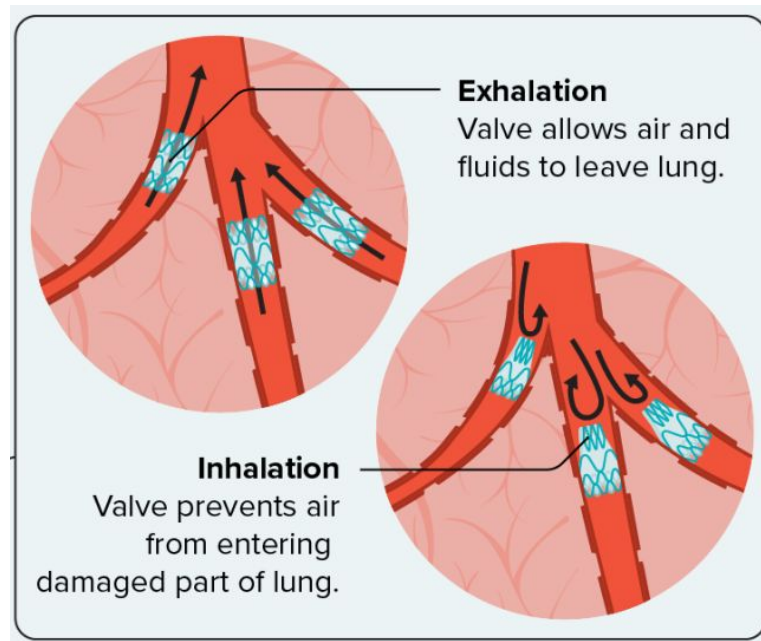

Figure 2 Endobronchial valve structure: 1 = hollow cylinder; 2 = valve inner bore; 3 = strut for holding; 4 = radial petals for fixing the valve in the bronchus; 5 = falling petal valve.



Endobronchial valves (EbV)

- First reports (that I could find) were in 2016
 - But they had been used in Russia for longer
- Placed by interventional pulmonology during bronchoscopy
- Can easily be removed if needed
- Works by collapsing the cavity

History of TB treatment

- **Before times:** Nothing
- **Around 1900:** Artificial pneumothorax
- **1940-60s:** antimycobacterials
- **Now:** Endobronchial valves

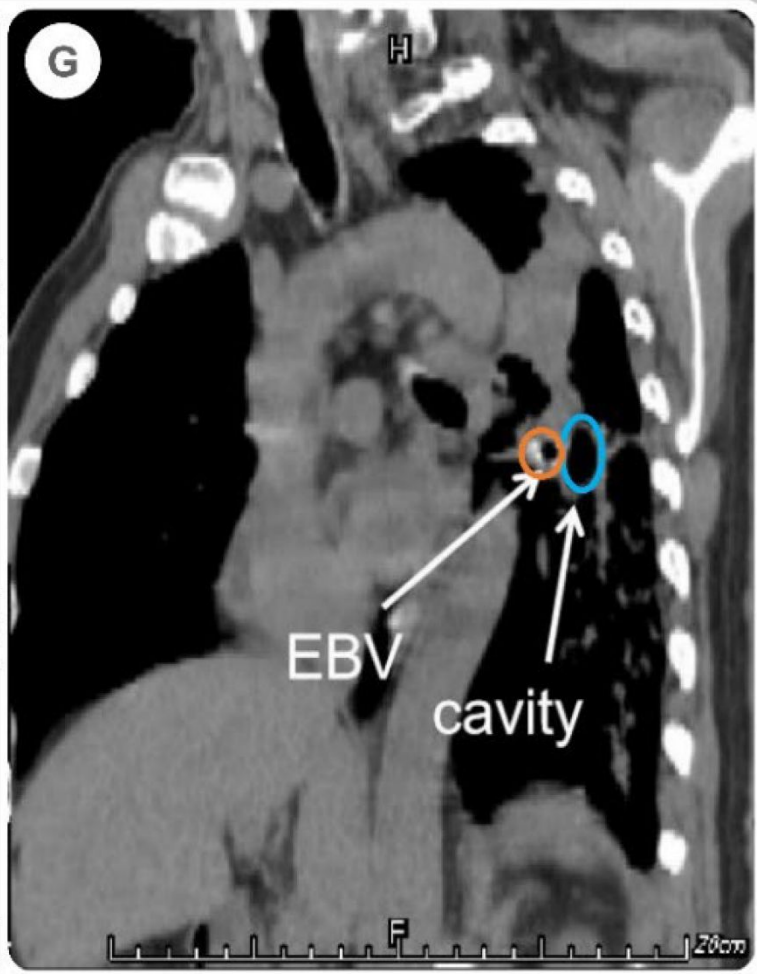
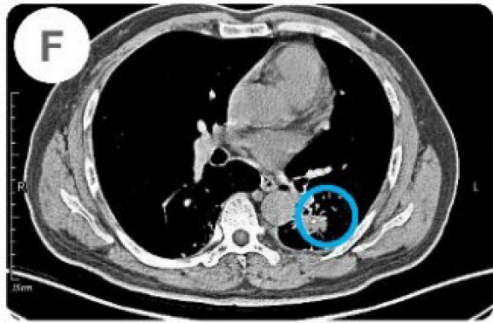
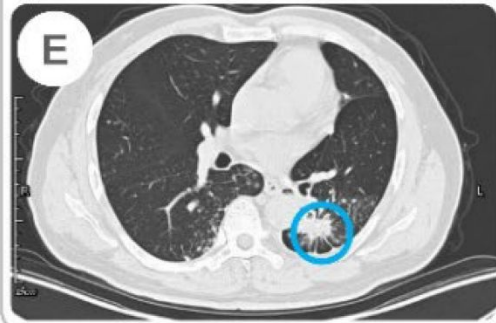
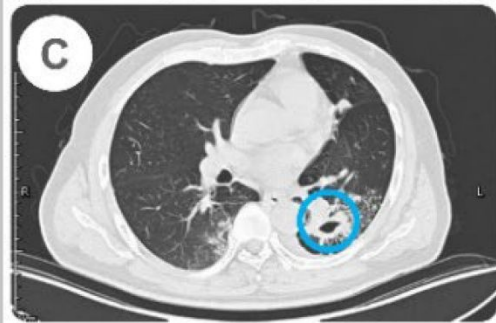
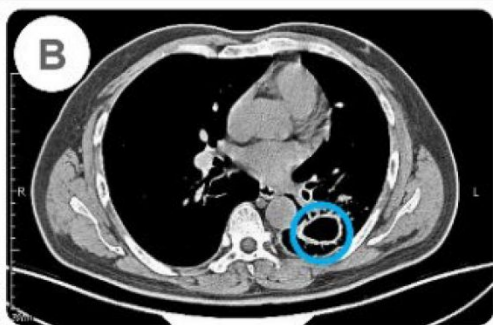

Levin et al (2016) ^[1.6]

- First RCT, based out of Russia (n=102) with MRD-TB
- Only side effect was cough
- Within **first 3 months** of study, 47 patients in the **intervention group cleared their cultures (96%)**, compared to 20 (**38%**) of controls (**p<0.0001**)

Levin et al (2016) ^[1.6]

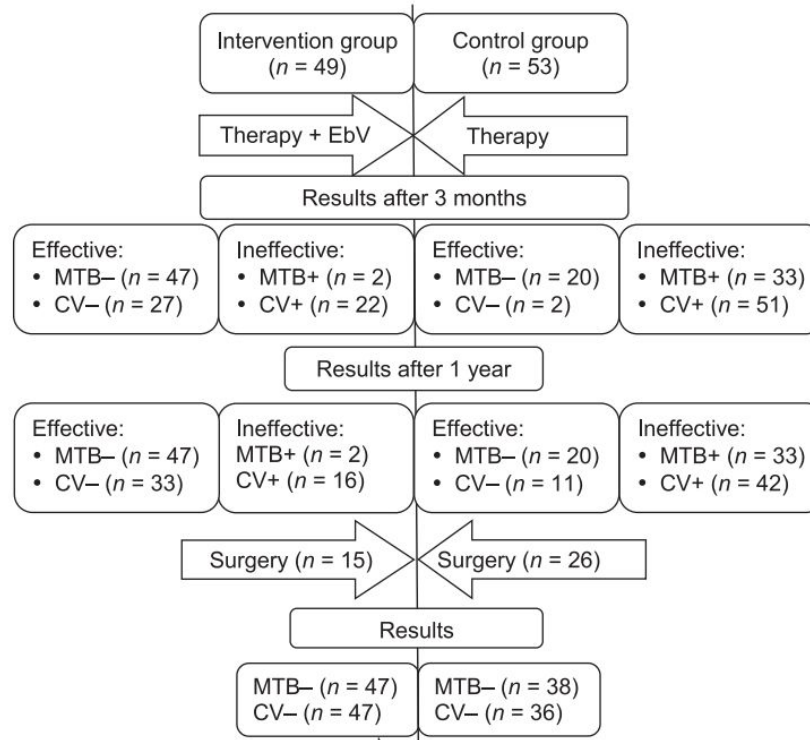

CV = cavity closure

Levin et al (2016) ^[1.6]

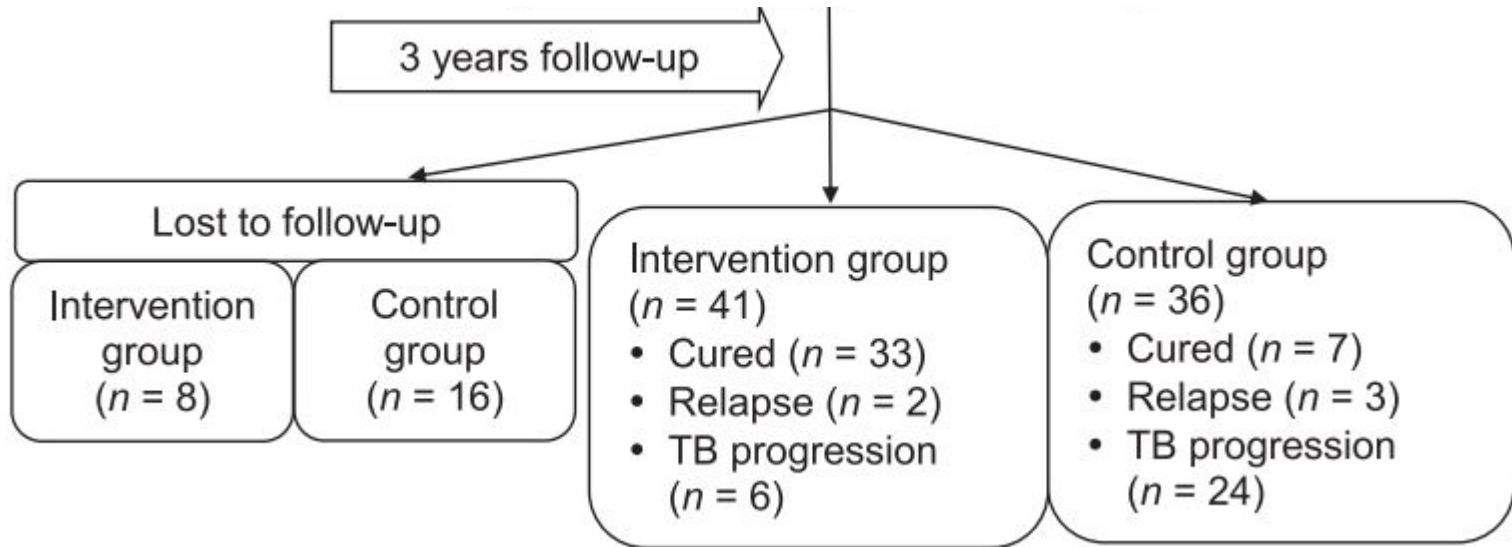

An et al (2022) ^[1.7]



- Case series of **35 patients** with MDR-TB in China who received EbV

An et al (2022) ^[1.7]

- Case series of 35 patients with MDR-TB in China who received EbV
- **100% cleared sputum** cultures
- Cavity **closure rate was 68.8%**

An et al (2022) [1.7]

- Case series of 35 patients with MDR-TB in China who received EbV
- **100% cleared sputum** cultures
- Cavity closure rate was **68.8%**
- Strong association between
 - Cavity closure –and–
 - Clearance of sputum cultures

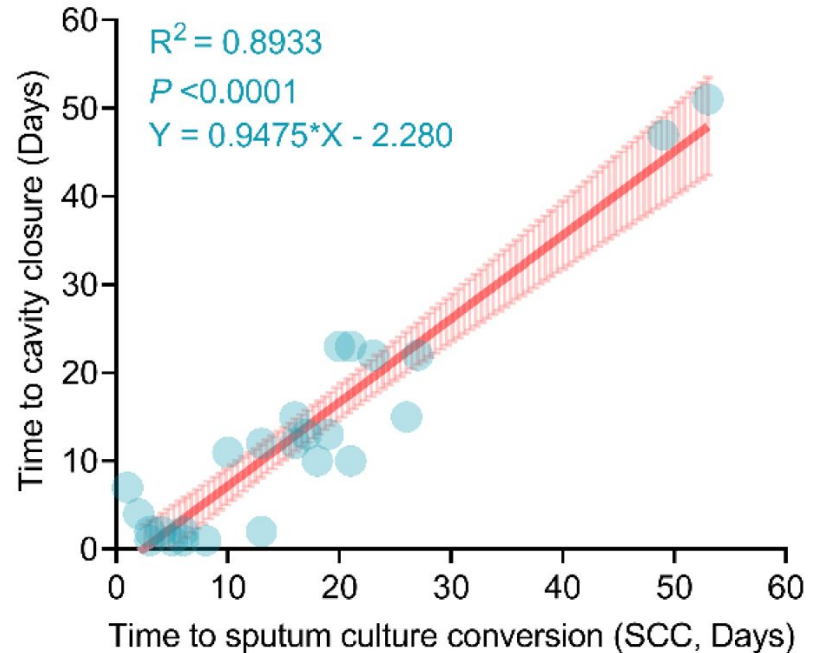

Learning points & take aways

Learning points & take aways



- Treatment for pulmonary TB carries a **heavy pill burden**, which may **influence compliance**
- Rifampin, isoniazid, pyrazinamide, & ethambutol (2HRZE/4-7HR aka **“RIPE”**) has been the mainstay for pulmonary TB **since the 1960s**
 - Historically, treatment was extended from 6 → 9 months in the case of **severe/cavitary disease**
- **Drug susceptible TB**: Newer evidence suggests that a shorter, **4 month**, course of **INH/rifapentine/PZA/moxi (2HPZM / 2HPM)** may be appropriate
 - **Regardless of smear grade, cavitation**, or radiographic extent
 - Conditional recommendation, moderate certainty
- **MDR TB**: **6 months BPaL(M)** preferred over 15+ months standard of care
 - **Strong recommendation**, very low certainty
- Elective **partial lung resection** should be considered in **MDR-TB** with **strong risk of relapse**
- **Endobronchial valves** may provide a non-invasive, safer way to achieve the same aims (almost no data though)

Slides available on hunteratliff1.com/talk/; Citations available via QR code or via the “citations” button on the website

Case #2

Time permitting, but it's short

Case 2: HPI

A **57 y/o M** with PMH including left knee MRSA PJI, recent RLE osteomyelitis, ESRD on PD presents to clinic for **TB evaluation**

- One year ago, his left TKA has **MRSA PJI**
 - **Dapto/RIF** → **doxy suppression**
- 6 months ago, had **osteomyelitis** of right first toe
 - 2 weeks **dapto/Zosyn** → 4 weeks **Zyvox** & **moxifloxacin** (avoid OPAT in case needs HD in future)

Case 2: HPI

A **57 y/o M** with PMH including left knee MRSA PJI, recent RLE osteomyelitis, ESRD on PD presents to clinic for **TB evaluation**

- One year ago, his left TKA has **MRSA PJI**
 - **Dapto/RIF** → **doxy suppression**
- 6 months ago, had **osteomyelitis** of right first toe
 - 2 weeks **dapto/Zosyn** → 4 weeks **Zyvox** & **moxifloxacin** (avoid OPAT in case needs HD in future)
- During malignancy workup (for **cough & weight loss**), found to have **cavitary nodule**
 - External records from **15 months ago** showed **lesion in same area**, slightly increased in size
 - **PPD 19mm**

Case 2: Not real

A **57 y/o M** with PMH including left knee MRSA PJI, recent RLE osteomyelitis, ESRD on PD presents to clinic for **TB evaluation**

- One year ago, his left TKA has **MRSA PJI**
 - **Dapto/RIF** → doxy suppression
- 6 months ago, had **osteomyelitis** of right first toe
 - 2 weeks **dapto/Zosyn** → 4 weeks **Zyvox** & **moxifloxacin** (avoid OPAT in case needs HD in future)
- During malignancy workup (for **cough & weight loss**), found to have **cavitary nodule**
 - External records from **15 months ago** showed **lesion in same area**, slightly increased in size
 - **PPD 19mm**

Not a real case
(at least yet)

Takeaway

1. Ask about TB risk factors
2. Only treat TB when you *are intending to* treat TB

Note

This scenario might cause pre-XDR TB. Zyvox resistance is rare